

1. Losanges

Réaliser les procédures suivantes :

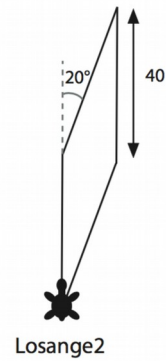

Créer une procédure "losange" utilisant deux variables :

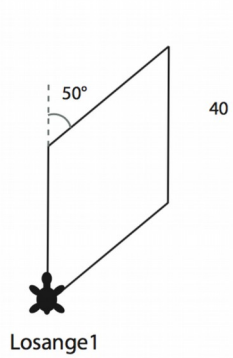
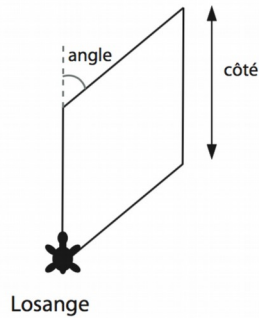

Utiliser la procédure "losange" pour réaliser les figures suivantes :

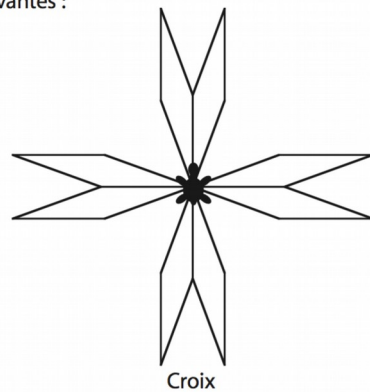
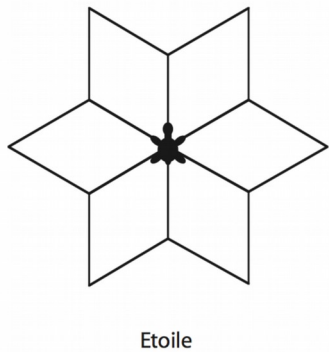

2. Parallélogrammes

Réaliser les procédures :

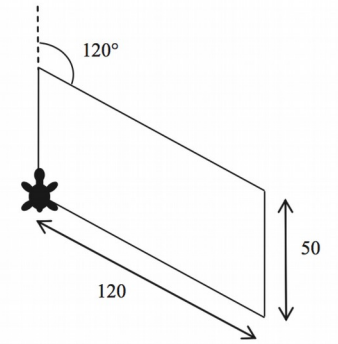
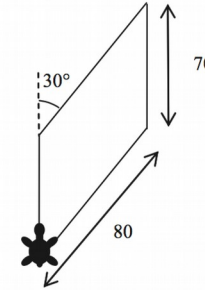
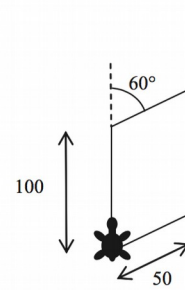

Créer la procédure parallélogramme en utilisant 3 variables

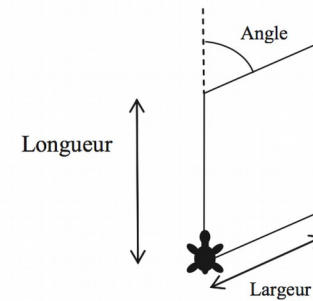

A l'aide de la procédure "parallélogramme", réaliser les procédures :

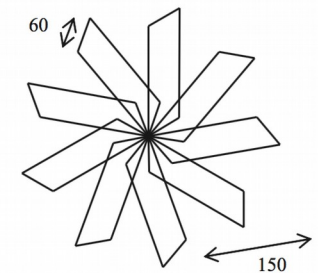
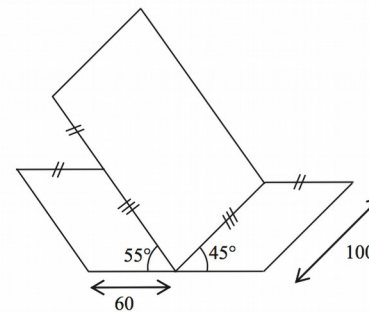

Les parallélogrammes sont identiques.